

BRIDGE 800

SCHEDE TECNICHE MANIGLIA 011227
TECHNICAL SHEET HANDLE 011227





Gruppo Pozzi

Gentile Cliente,
grazie per aver acquistato il nostro sistema scorrevole per ante sospese Bridge800.
Ti ricordiamo di leggere le istruzioni e/o guardare il video completamente prima di iniziare il
montaggio. Ci sono configurazioni che necessitano di particolari posizionamenti.

System Holz

*Dear Customer,
thank you for purchasing our sliding system Bridge800 for suspended doors. Before you begin,
read the instructions and / or watch the video completely. Some configurations require special
placements.*

System Holz

CALCOLO DIMENSIONI ANTA

DOOR SIZE CALCULATION

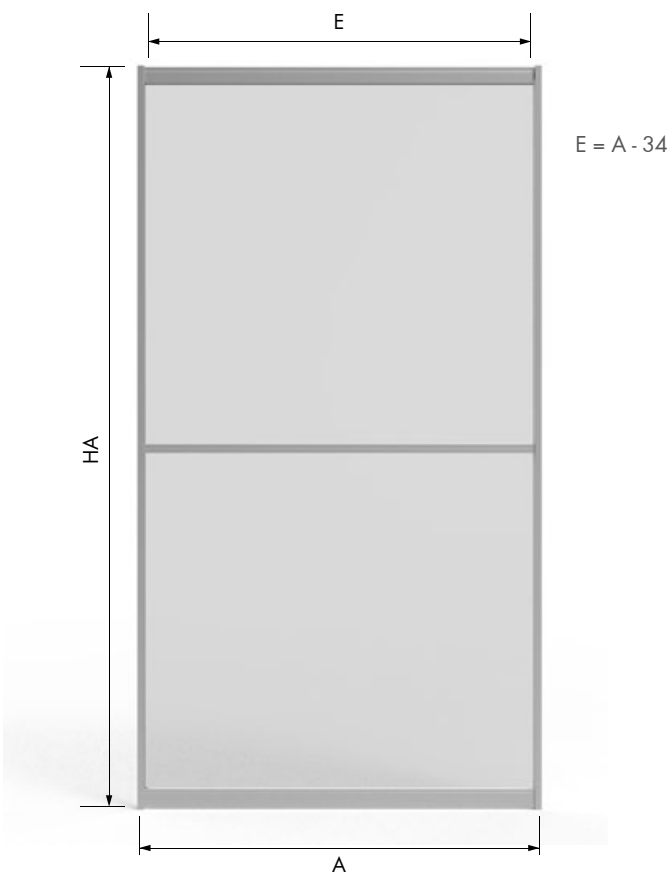
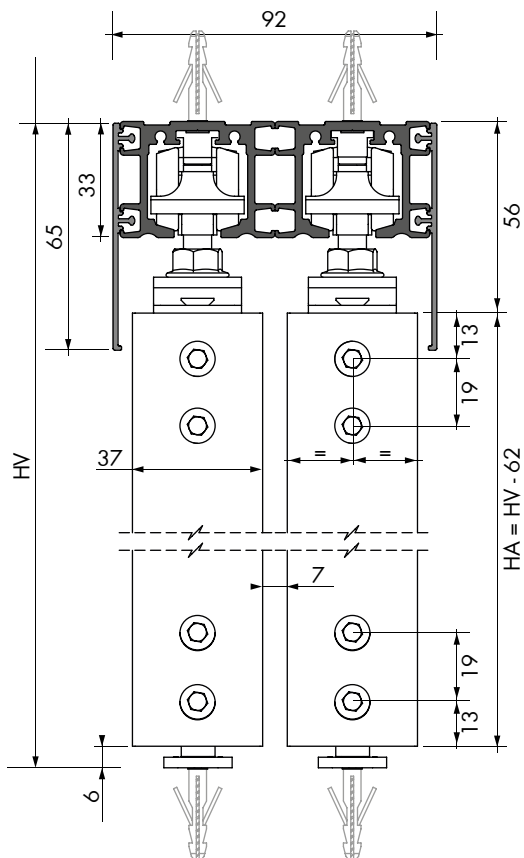

Lunghezza binari / Rail length = $B - 2$

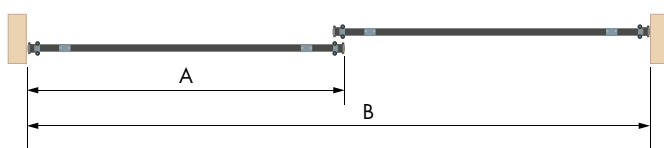

$A = \frac{B + 18}{2}$ Freno apertura e chiusura
 Opening and closing soft closing device

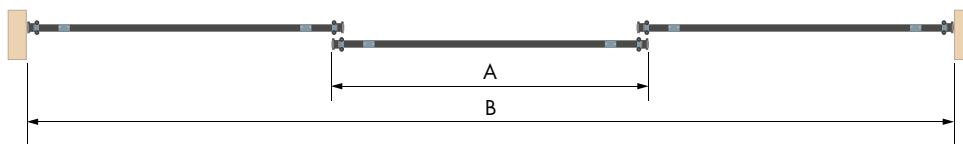

$A = \frac{B + 36}{3}$ Freno apertura e chiusura
 Opening and closing soft closing device

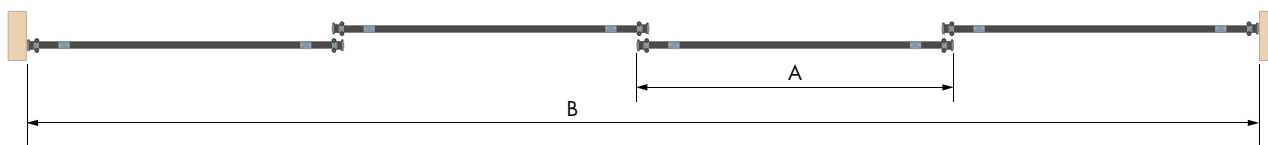

$A = \frac{B + 54}{4}$ Freno apertura e chiusura
 Opening and closing soft closing device

DIMENSIONI VETRO/PANNELLO
 CON TRAVERSO INFERIORE 011228

GLASS/PANEL DIMENSION
 WITH LOWER CROSSPIECE 011228

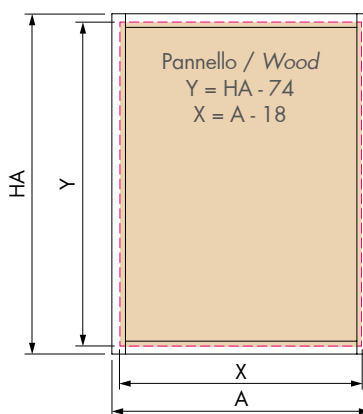
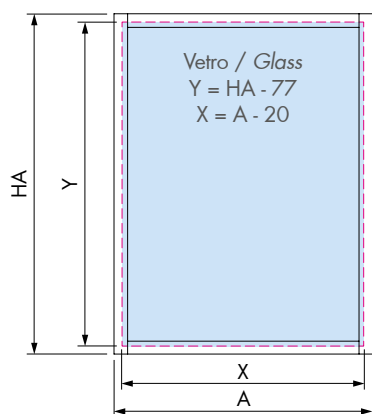

Tolleranze su dimensioni
 Tolerances on dimension
 +0 / -1mm

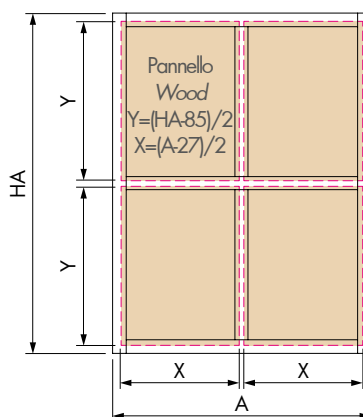
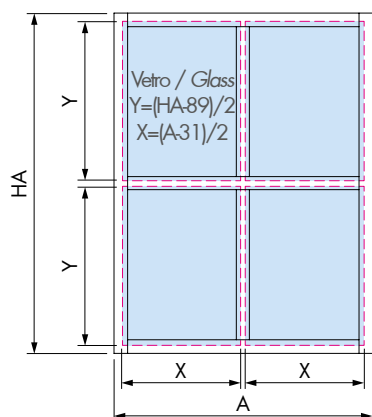
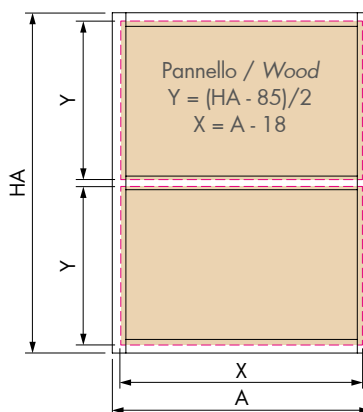
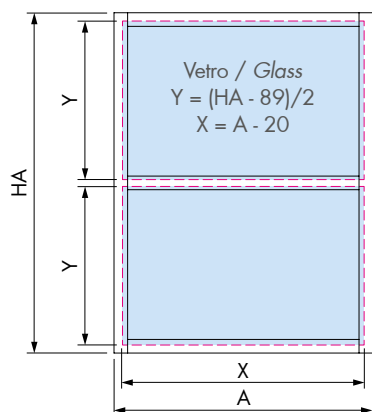

DIMENSIONI VETRO/PANNELLO
 CON TRAVERSO INFERIORE 010660

GLASS/PANEL DIMENSION
 WITH LOWER CROSSPIECE 010660

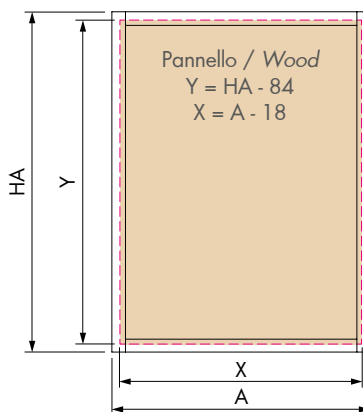
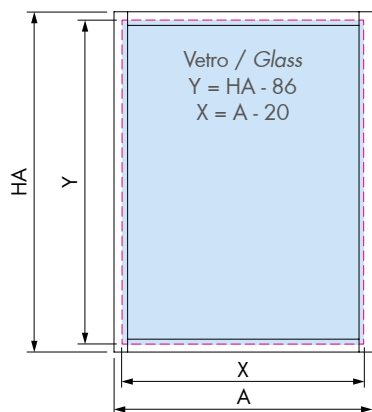

Tolleranze su dimensioni
 Tolerances on dimension
 +0 / -1mm

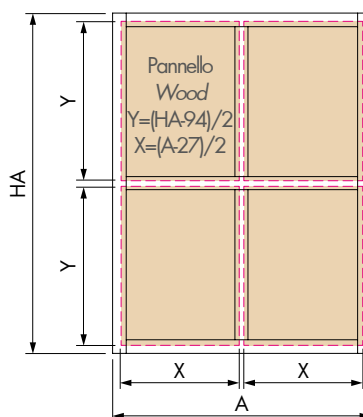
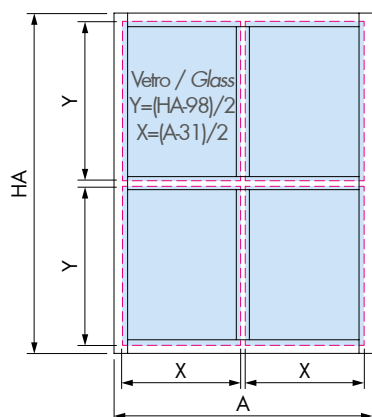
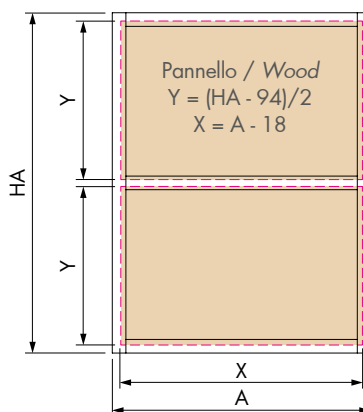
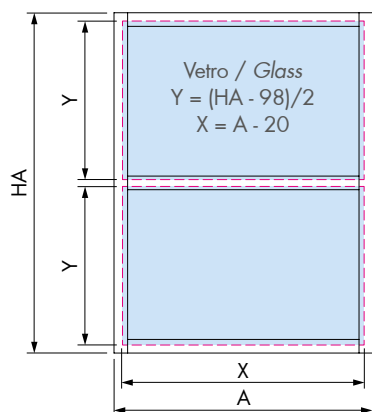

ALL THE FURNITURE HARDWARE



POZZI ferramenta

Più di 30.000 articoli commercializzati per il settore della ferramenta per mobili con oltre 64 paesi serviti.
More than 30.000 products marketed of furniture accessories with over 64 countries served.

SH System Holz

Produttore specializzato nello sviluppo di cerniere per mobili, sistemi scorrevoli e profili e ante in alluminio.
Manufacturer specializing in the development of hinges for furniture, sliding systems and aluminium doors and profile.

QS OXIDAL SYSTEM

Leader nella pulitura e ossidazione anodica di particolari in alluminio con 37 vasche e 2 forni di asciugatura.
Leading company in any type of surface treatment on aluminium materials, with 37 baths and 2 drying ovens.

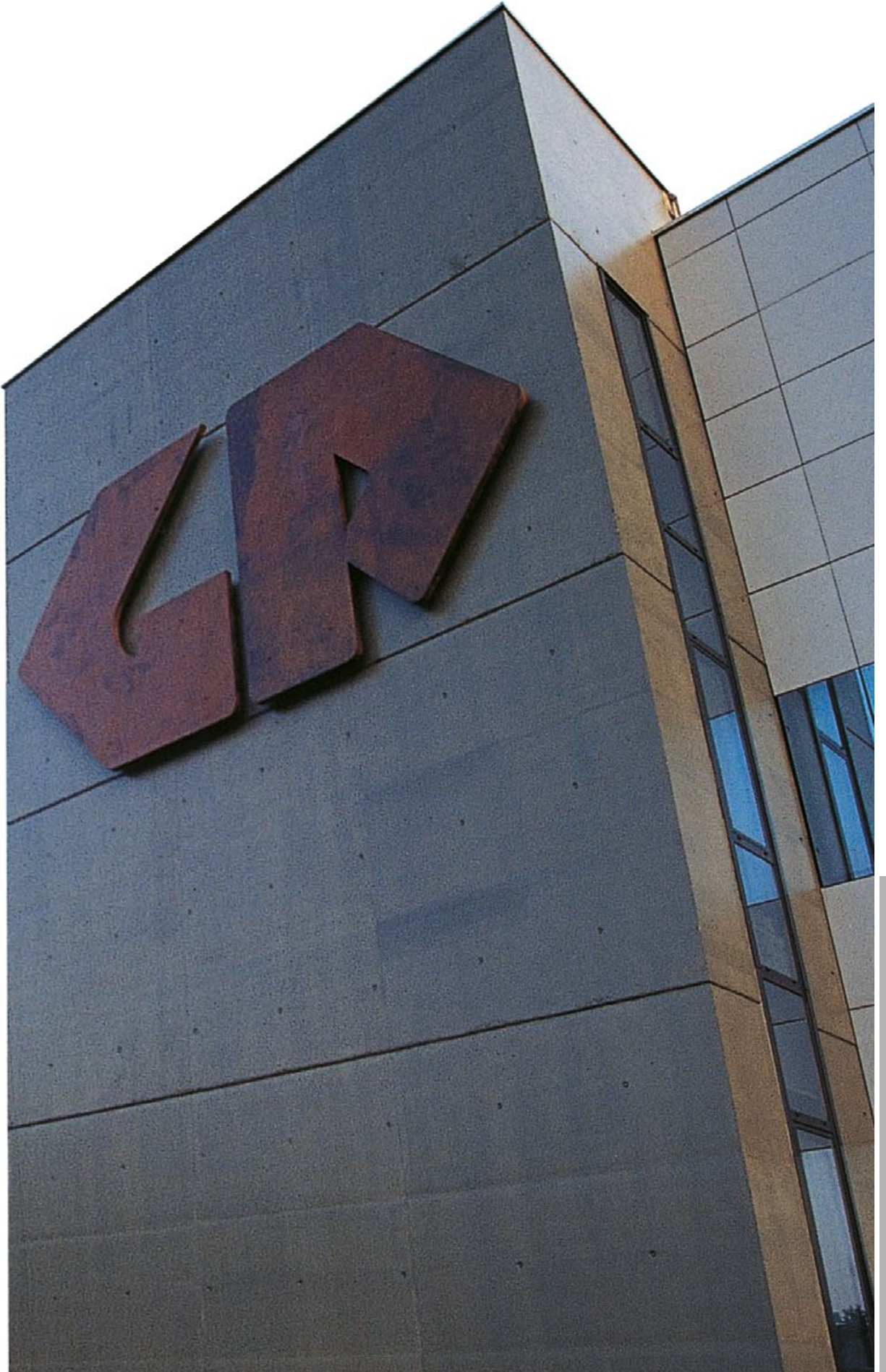

SH System Holz

SYSTEM HOLZ SRL

Via Valsorda, n.6
22040 Cremnago di Inverigo, (CO) ITALY
Tel. +39 031 6949111 - Fax. +39 031 698073
infosh@gruppopozzi.it - www.gruppopozzi.it

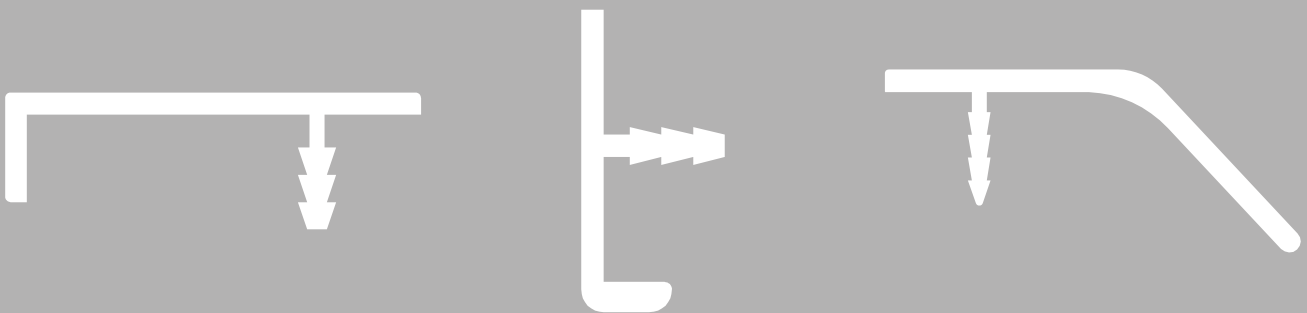

Gruppo Pozzi