

# BRIDGE 800

SCHEDE TECNICHE MANIGLIA 010884  
*TECHNICAL SHEET HANDLE 010884*





**Gruppo Pozzi**

Gentile Cliente,  
grazie per aver acquistato il nostro sistema scorrevole per ante sospese Bridge800.  
Ti ricordiamo di leggere le istruzioni e/o guardare il video completamente prima di iniziare il  
montaggio. Ci sono configurazioni che necessitano di particolari posizionamenti.

System Holz

*Dear Customer,  
thank you for purchasing our sliding system Bridge800 for suspended doors. Before you begin,  
read the instructions and / or watch the video completely. Some configurations require special  
placements.*

System Holz

CALCOLO DIMENSIONI ANTA

DOOR SIZE CALCULATION

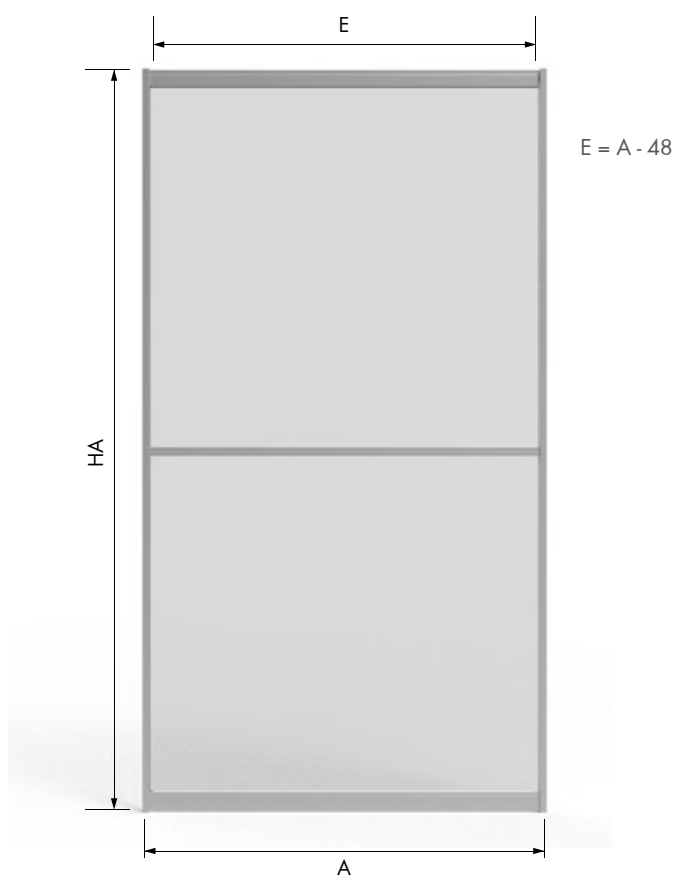
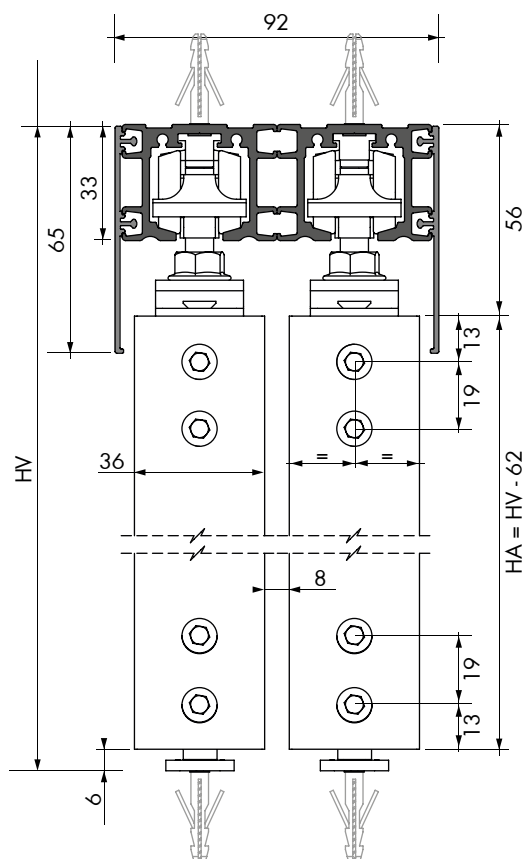

Lunghezza binari / Rail length =  $B - 2$

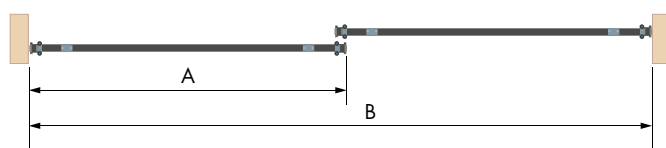

$A = \frac{B + 25}{2}$  Freno apertura e chiusura  
 Opening and closing soft closing device

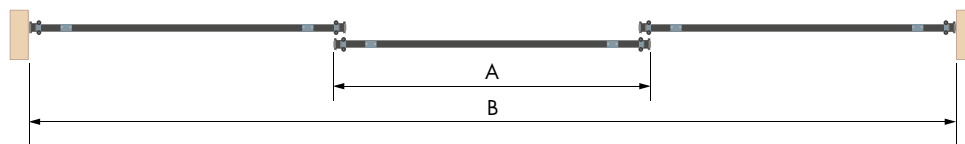

$A = \frac{B + 50}{3}$  Freno apertura e chiusura  
 Opening and closing soft closing device

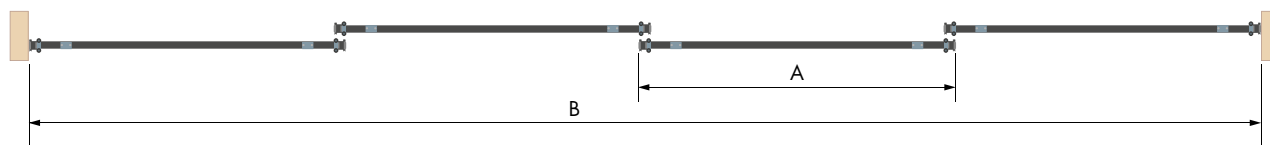

$A = \frac{B + 75}{4}$  Freno apertura e chiusura  
 Opening and closing soft closing device

DIMENSIONI VETRO/PANNELLO  
 CON TRAVERSO INFERIORE 011228

GLASS/PANEL DIMENSION  
 WITH LOWER CROSSPIECE 011228

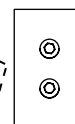
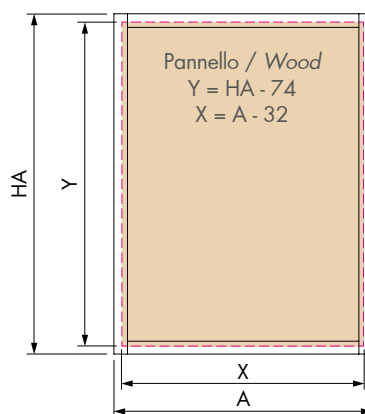
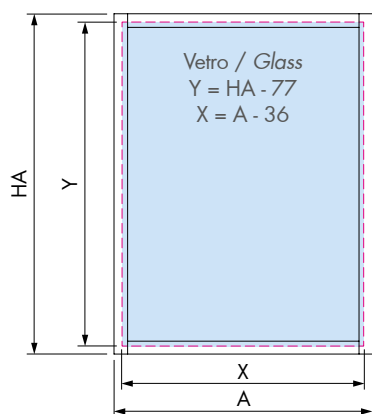

Tolleranze su dimensioni  
 Tolerances on dimension  
 +0 / -1mm

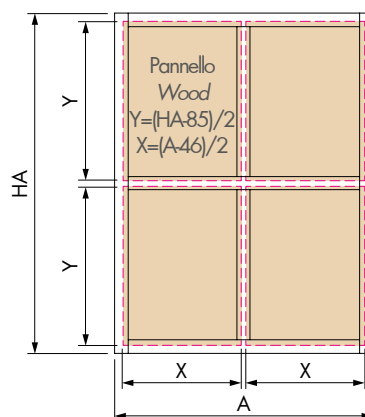
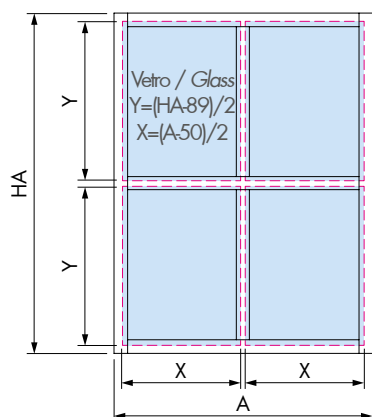
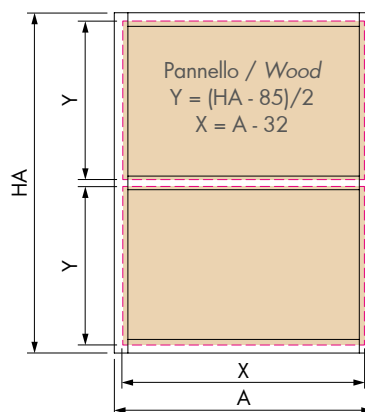
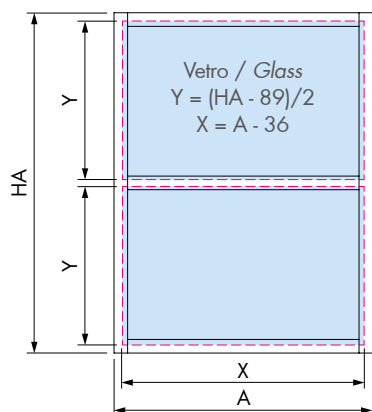

DIMENSIONI VETRO/PANNELLO  
 CON TRAVERSO INFERIORE 010660

GLASS/PANEL DIMENSION  
 WITH LOWER CROSSPIECE 010660

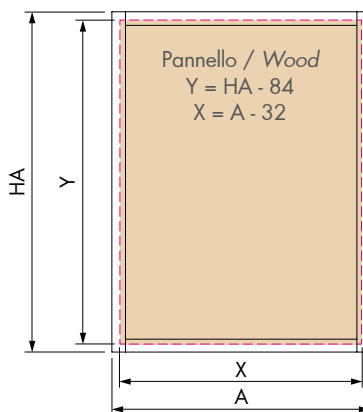
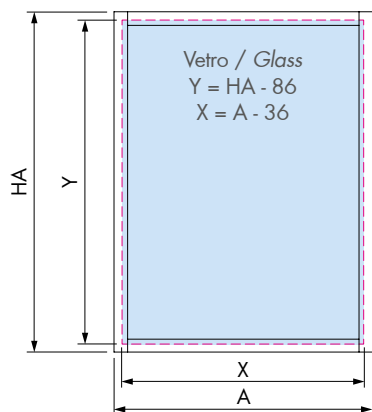

Tolleranze su dimensioni  
 Tolerances on dimension  
 +0 / -1mm

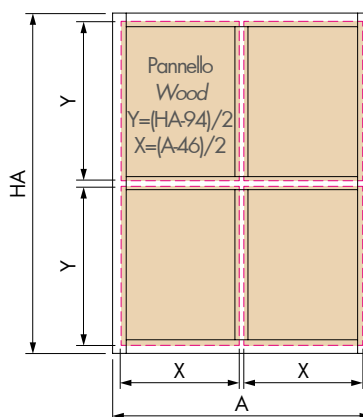
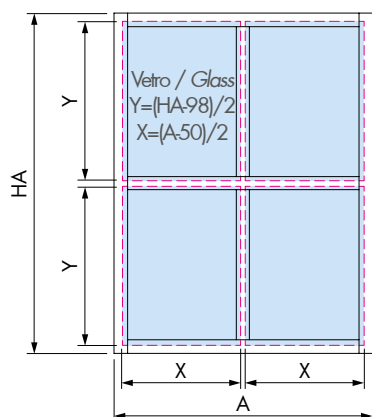
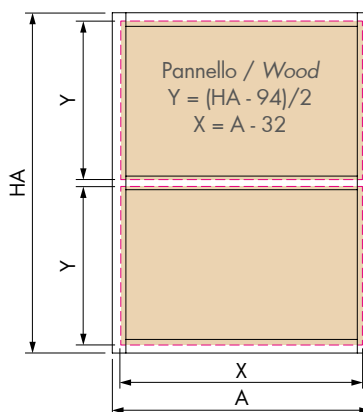
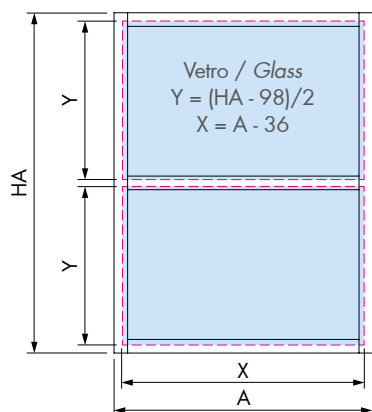

# ALL THE FURNITURE HARDWARE



## **POZZI** ferramenta

Più di 30.000 articoli commercializzati per il settore della ferramenta per mobili con oltre 64 paesi serviti.  
*More than 30.000 products marketed of furniture accessories with over 64 countries served.*

## **SH** System Holz

Produttore specializzato nello sviluppo di cerniere per mobili, sistemi scorrevoli e profili e ante in alluminio.  
*Manufacturer specializing in the development of hinges for furniture, sliding systems and aluminium doors and profile.*

## **QS** OXIDAL SYSTEM

Leader nella pulitura e ossidazione anodica di particolari in alluminio con 37 vasche e 2 forni di asciugatura.  
*Leading company in any type of surface treatment on aluminium materials, with 37 baths and 2 drying ovens.*



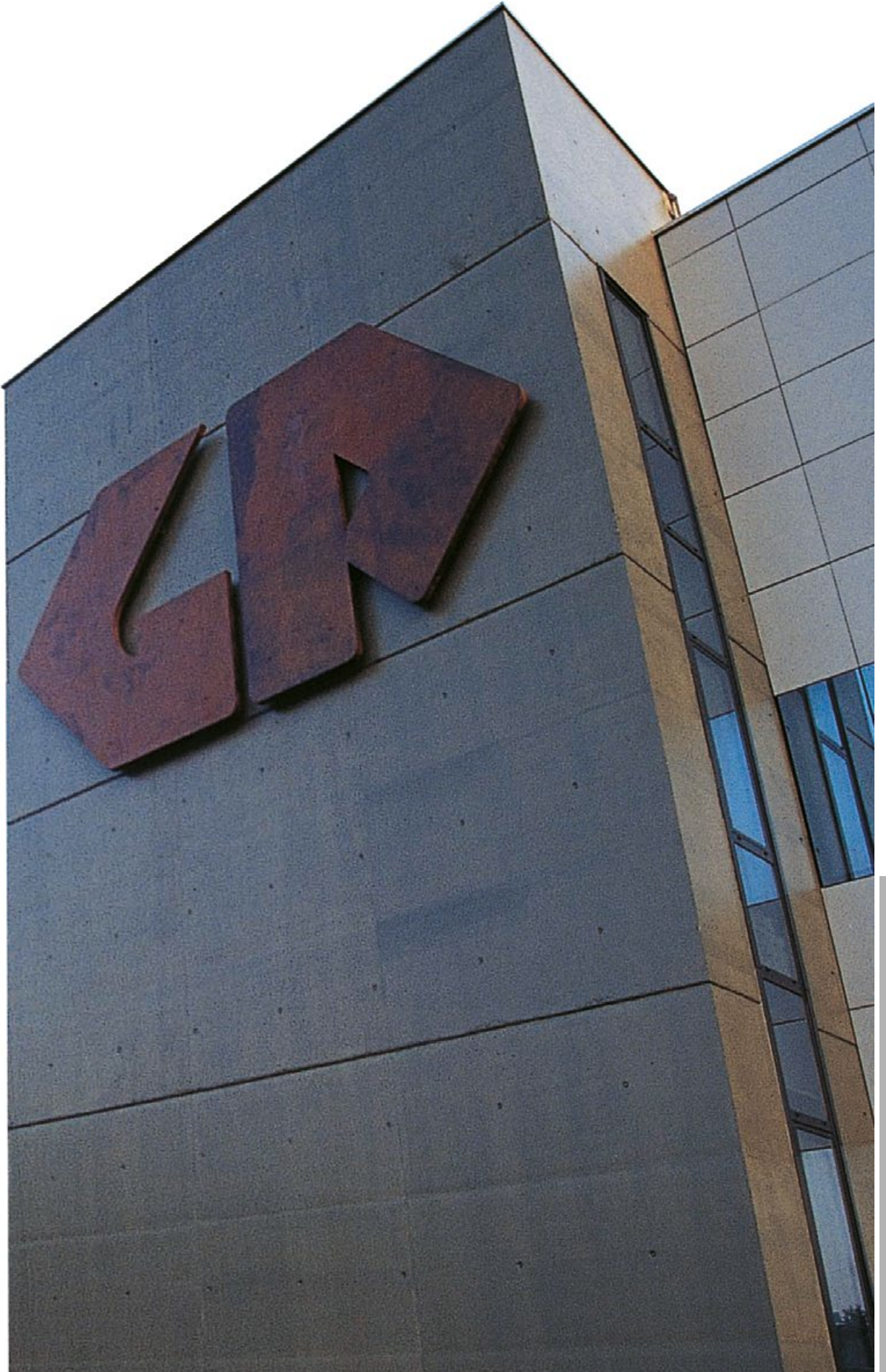



# **SH** System Holz

**SYSTEM HOLZ SRL**

Via Valsorda, n.6  
22040 Cremnago di Inverigo, (CO) ITALY  
Tel. +39 031 6949111 - Fax. +39 031 698073  
infosh@gruppopozzi.it - www.gruppopozzi.it

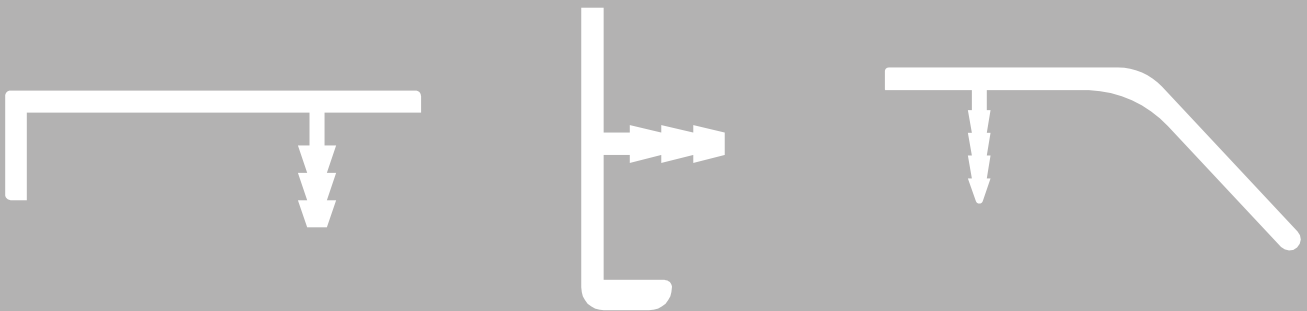

**Gruppo Pozzi**